

Z-80 CPU

USERS MANUAL

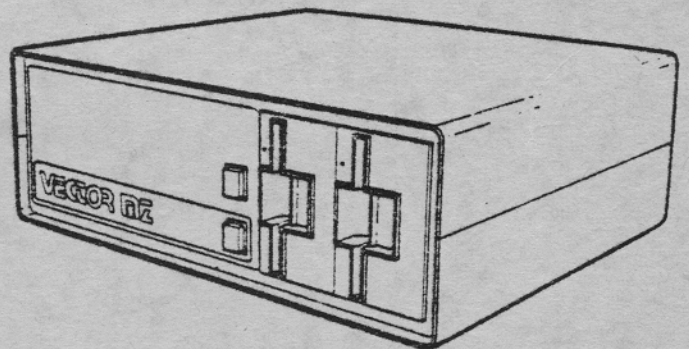
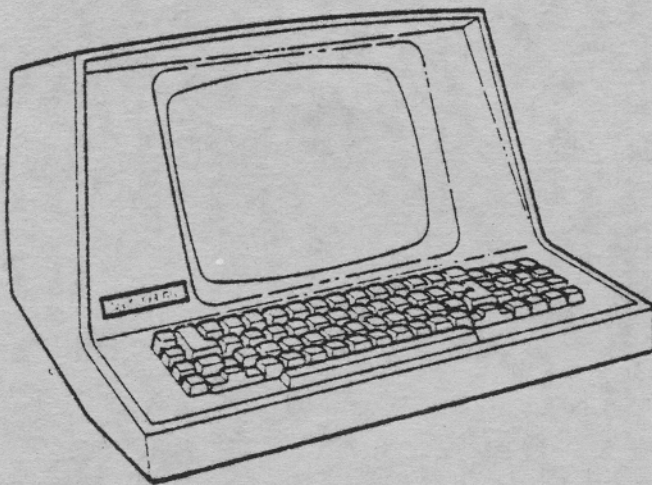

VECTOR
VECTOR GRAPHIC, INC.

Z80 BOARD, REVISION 2

USERS MANUAL

Revision A

May 17, 1979

*Z-80 is a registered trademark of Zilog Corporation.

Copyright 1979 Vector Graphic Inc.

Copyright 1979 by Vector Graphic Inc.
All rights reserved.

Disclaimer

Vector Graphic makes no representations or warranties with respect to the contents of this manual itself, whether or not the product it describes is covered by a warranty or repair agreement. Further, Vector Graphic reserves the right to revise this publication and to make changes from time to time in the content hereof without obligation of Vector Graphic to notify any person of such revision or changes, except when an agreement to the contrary exists.

Revisions

The date of release and revision letter of each page herein appears at the bottom of each page. The revision letter such as A or B changes if the manual has been improved but the product itself has not been significantly modified. The date of release and revision letter on the Title Page corresponds to that of the page most recently revised. When the product itself is modified significantly, the product will get a new revision number, as shown on the manual's title page, and the manual will revert to revision A, as if it were treating a brand new product. EACH MANUAL SHOULD ONLY BE USED WITH THE PRODUCT IDENTIFIED ON THE TITLE PAGE.

REPAIR AGREEMENT

The Z-80 Board sold hereunder is sold "as is", with all faults and without any warranty, either expressed or implied, including any implied warranty of fitness for intended use or merchantability. However, the above notwithstanding, VECTOR GRAPHIC, INC., will, for a period of ninety (90) days following delivery to customer, repair or replace any Z-80 Board that is found to contain defects in materials or workmanship, provided:

1. Such defect in material or workmanship existed at the time the Z-80 Board left the VECTOR GRAPHIC, INC., factory;
2. VECTOR GRAPHIC, INC., is given notice of the precise defect claimed within ten (10) days after its discovery;
3. The Z-80 Board is promptly returned to VECTOR GRAPHIC, INC., at customer's expense, for examination by VECTOR GRAPHIC, INC., to confirm the alleged defect, and for subsequent repair or replacement if found to be in order.

Repair, replacement or correction of any defects in material or workmanship which are discovered after expiration of the period set forth above will be performed by VECTOR GRAPHIC, INC., at Buyer's expense, provided the Z-80 Board is returned, also at Buyer's expense, to VECTOR GRAPHIC, INC., for such repair, replacement or correction. In performing any repair, replacement or correction after expiration of the period set forth above, Buyer will be charged in addition to the cost of parts the then-current VECTOR GRAPHIC, INC., repair rate. At the present time the applicable rate is \$35.00 for the first hour, and \$18.00 per hour for every hour of work required thereafter. Prior to commencing any repair, replacement or correction of defects in material or workmanship discovered after expiration of the period for no-cost-to-Buyer repairs, VECTOR GRAPHIC, INC., will submit to Buyer a written estimate of the expected charges, and VECTOR GRAPHIC, INC., will not commence repair until such time as the written estimate of charges has been returned by Buyer to VECTOR GRAPHIC, INC., signed by duly authorized representative authorizing VECTOR GRAPHIC, INC., to commence with the repair work involved. VECTOR GRAPHIC, INC., shall have no obligation to repair, replace or correct any Z-80 Board until the written estimate has been returned with approval to proceed, and VECTOR GRAPHIC, INC., may at its option also require prepayment of the estimated repair charges prior to commencing work.

Repair Agreement void if the enclosed card is not returned to VECTOR GRAPHIC, INC. within ten (10) days of end consumer purchase.

TABLE OF CONTENTS

<u>Section</u>	<u>Page</u>
Repair Agreement	
Table of Contents	
I. Introduction	
1.1 Specifications.....	1-1
1.2 Description of the Z-80 Revision 2.....	1-2
II. Users Guide	
2.1 System Compatibility.....	2-1
2.2 Using Dynamic Memory - Bus Lines 55 and 66.....	2-1
2.3 Not Using Dynamic Memory.....	2-2
2.4 High Order Address Lines During I/O.....	2-2
2.5 Running the System at 2 or 4 MHz.....	2-3
2.6 Automatic Wait States for Slow Memories.....	2-3
2.7 Generating MWRITE.....	2-3
III. Theory of Operation	
3.1 Power.....	3-1
3.2 Clock Generation.....	3-1
3.3 High Order Address Lines During I/O.....	3-1
3.4 Control Signals.....	3-2
3.5 Wait States.....	3-2
3.6 Miscellaneous Logic.....	3-3
Figures.....	3-4
IV. Schematics	
Board Layout.....	4-1
Schematic Errata.....	4-2
Schematic.....	4-3

I. INTRODUCTION

1.1 SPECIFICATIONS

Bus Compatibility	S-100
Processor	Mostek Z-80A (MK-3880N)
Number of Data Bits	8
Number of Address Bits	16
Instructions	158, including all 78 8080 instructions
Clock speed	2 or 4 MHz, jumper selectable Standard: 4 MHz
Interrupts	All three Z-80 modes S-100 vectored interrupt lines are not handled
I/O devices	256 I/O addresses
Dynamic RAM	Supports dynamic memory by sending Z-80 RFSH on bus line 66; and using fast reset received on line 55
Static RAM	Jumper option to generate reset on Z-80 board instead of fast reset on line 55
MWRITE	Jumper option to generate MWRITE on board Standard: option enabled
Wait state generation for memories slower than about 300 ns.	Jumper option to generate one wait state each time memory is addressed Standard: option not enabled
High address lines during I/O	For peripherals that need it, high address lines mirror low address lines during I/O
Bus load	1 low power TTL load on all inputs
Buffering	All outputs buffered
Card extractors	Standard
Power	+8Vdc @ 450 mA (Typ)

1.2 DESCRIPTION OF THE Z-80 REVISION 2 BOARD

The Vector Graphic Z-80 board is designed around the powerful Z-80 microprocessor chip. The board is fully S-100 bus compatible, providing interchangeability between systems. All input and output lines are fully buffered. Loading on the bus is no more than 1 TTL load.

In addition, the board has the necessary circuitry to work well with dynamic memories, such as Vector Graphic's 48K board.

Simplicity of design has been stressed to enhance reliability of operation by the use of MSI and LSI integrated circuits. This goal has been achieved while not sacrificing any performance factors.

II. USERS GUIDE

For the location of jumper areas, refer to the silk-screen diagram on page 4.1

2.1 SYSTEM COMPATIBILITY

The Z-80 Board is designed for operation in an S-100 system. It generates ALL the S-100 signals originally generated by 8080 CPU boards following the S-100 definition, and accepts as input the S-100 signals intended as input to an 8080 processor board, with two exceptions: 1) Vectored interrupt request lines (S-100 lines 4 - 11) are not received or handled in any way by the board. 2) The timing of some signals, particularly PSYNC and the status signals, is slightly different than that produced by 8080 boards, but the differences are usually inconsequential. Also, a few additional lines are used, required for dynamic memory in a Z-80 based system, and are explained below.

For power, the board only requires the +8V unregulated source on bus line 1.

2.2 USING DYNAMIC MEMORY - BUS LINES 55 AND 66

The Z-80 Board as manufactured is configured for use with dynamic memory boards. The following paragraphs will explain how.

The Z-80 chip provides a $\overline{\text{RFSH}}$ signal on pin 28 used to refresh dynamic memory, thus enabling easier use of dynamic memory in a system. This signal is buffered directly onto line 66 of the bus. Thus appropriately designed dynamic memory boards can be used in conjunction with this Z-80 board, as in the Vector Graphic MZ computer. For use of the $\overline{\text{RFSH}}$ signal in designing dynamic memory components, refer to Z-80 data books.

Dynamic memory requires that each byte be read and rewritten continuously. If the processor is halted for too long an interval, memory data can be lost. The $\overline{\text{RESET}}$ signal which is created by circuitry on the Z-80 board from an incoming $\overline{\text{PRESET}}$ signal on line 75 is too long. Hence, for use with dynamic memory, THE BOARD IS SHIPPED WITH THIS CIRCUITRY DISABLED. Instead,

the dynamic memory board is expected to create a fast reset signal on bus line 55, which is then used as input to the processor RESET pin.

If you have obtained a particular Z-80 board which has had the RESET circuit re-enabled, as described in the following section, then simply reverse the steps in the following section in order to use the board with a dynamic memory board that generates a fast reset on bus line 55.

2.3 NOT USING DYNAMIC MEMORY

If the system is not using the Vector Graphic 48K Dynamic Memory Board or other dynamic memory board which generates a fast reset signal, then you must enable the generation of RESET by the Z-80 board. Once enabled, the board will generate RESET using the PRESET signal on bus line 75, or, when the system is first turned on, using a resistor-capacitor circuit on the board. The necessary circuitry already exists on the board, except as follows. Take the following steps:

- a. Install a 100 ohm 1/4 watt resistor in the spot marked to the left of U16.
- b. Make sure there is capacitor installed in a marked location very close to the lower left hand corner of the Z-80 chip. If not, install a 22 or 25 MFD 12 to 16 V axial electrolytic capacitor at that spot, with the plus end to the LEFT.
- c. Install a jumper across area D, found at the bottom of the board, just above the middle of the end connector. This jumper connects bus line 75 - PRESET, to the reset circuitry.
- d. Cut the jumper connecting pad E and pad F. It is usually installed on the back of the board. Pad E is at the bottom of the board, on the left side, and F is between U6 and U7. This jumper connects bus line 55 to the Z-80 RESET pin.

2.4 HIGH ORDER ADDRESS LINES DURING I/O

The Z-80 microprocessor presents the peripheral address byte on the low order byte of address (bits 0-7) during an I/O operation. However, some peripheral boards require the address byte to be present on the high order

Z-80 Board Revision 2 Users Manual

byte. In order to maintain compatibility in all cases, logic has been included to "mirror" the peripheral address on the low order byte also onto the high order byte during an I/O operation.

2.5 RUNNING THE SYSTEM AT 2 OR 4 MHz

Jumper area: A

Connections as manufactured: none

Function: selects 2 or 4 MHz CPU operation. The Z-80 chip is capable of 4 MHz operation, but some peripheral boards are not. The board is shipped for operation at 4 MHz.

Options: to operate at 2 MHz, install a jumper in area A.

2.6 AUTOMATIC WAIT STATES FOR SLOW MEMORIES

Jumper area: B

Connections as manufactured: none

Function: When this jumper is connected, the Z-80 board will cause one wait state to be inserted in each memory access instruction. This is needed when using memories in the system slower than about 300 ns.

Options: to enable the automatic wait state, add a the jumper in area B.

2.7 GENERATING MWRITE

Jumper area: C

Connections as manufactured: jumper installed.

Function: when connected, the Z-80 board will generate the MWRITE signal (S-100 line 68). You will want to disconnect this jumper if there is some other source of MWRITE in the system, such as a front panel.

Options: if MWRITE generation is not wanted, remove the jumper in area C.

III. THEORY OF OPERATION

3.1 POWER

The Vector Graphic Z-80 board requires only a single 5 volt DC power source and regulates the raw +8V with a 7805 regulator. Ample bypass and filtering is provided by electrolytic and ceramic capacitors distributed on the board.

3.2 CLOCK GENERATION

See Figure 1. This board has been designed to operate at both 2 MHz and 4 MHz. Although the Z-80 requires only a single phase clock for operation, the Vector Graphic Z-80 board has circuitry to generate the $\phi 1$, $\phi 2$ and CLK signals required by the S-100 bus and components that interface to it.

The basic source of all the clock signals is an on-board 8 MHz crystal oscillator. The 8 MHz signal is applied to divide by 2 and divide by 4 logic formed by flip-flops U8a and U8b. The 2 MHz output at U8-8 is used for the CLK signal.

The 8 MHz clock and 4 MHz output at U8-6 are applied to gating logic to select, per jumper position, 2 or 4 MHz system operation. The subsequent output of this gating logic is applied to U7-11. By using both the Q and \bar{Q} outputs of U7 the two phase clock relationship is achieved and by gating the input clock with U7-9 the required delay between clocks is achieved. $\phi 1$ and $\phi 2$ signals are applied to bus lines 24 and 25. The Z-80 is clocked by $\phi 2$.

3.3 HIGH ORDER ADDRESS LINES DURING I/O

As noted in the User's Guide, to satisfy the needs of some peripheral boards, logic has been included to "mirror" the peripheral address on the low order byte also onto the high order byte during an I/O operation. This is implemented by "wire or"ing the buffered low order address bits with the buffered high order address bits. The tri-state buffers used are enabled during an I/O operation only.

3.4 CONTROL SIGNALS

The Z-80 microprocessor has five basic control lines which are used to read or write data to and from memory or I/O devices. these signals are:

1. $\overline{\text{MREQ}}$ - output, active low. The memory request signal indicates that the address bus holds a valid address for a memory reference operation.
2. $\overline{\text{M1}}$ - output, active low. $\overline{\text{M1}}$ indicates that the current machine cycle is the op code fetch cycle of an instruction execution.
3. $\overline{\text{IORQ}}$ - output, active low. The $\overline{\text{IORQ}}$ signal indicates that the lower half of the address bus holds a valid I/O address for an I/O read or write operation. An $\overline{\text{IORQ}}$ signal is also generated when an interrupt is being acknowledged to indicate that an interrupt response vector can be placed on the data bus.
4. $\overline{\text{RD}}$ - output, active low. $\overline{\text{RD}}$ indicates that the Z-80 wants to read data from memory or an I/O device.
5. $\overline{\text{WR}}$ - output, active low. $\overline{\text{WR}}$ indicates that the Z-80 data bus holds valid data to be stored in the addressed memory or I/O device.

By logical manipulation of the above signals the S-100 bus type signals are created. Thus, $\overline{\text{SMEMR}}$ is the logical "AND" of $\overline{\text{RD}}$ and $\overline{\text{MREQ}}$, $\overline{\text{MWRITE}}$ is $\overline{\text{WR}}$ and $\overline{\text{MREQ}}$ (produced by NORing $\overline{\text{WR}}$ and $\overline{\text{SOUT}}$), $\overline{\text{SOUT}}$ is $\overline{\text{WR}}$ and $\overline{\text{IORQ}}$, $\overline{\text{SINP}}$ is $\overline{\text{RD}}$ and $\overline{\text{IORQ}}$, $\overline{\text{PDBIN}}$ is $\overline{\text{RD}}$, and $\overline{\text{PWR}}$ is $\overline{\text{WR}}$. All the previous listed signals are fully buffered to the bus.

The Z-80 microprocessor does not have an equivalent output to $\overline{\text{PSYNC}}$ so circuitry has been included to emulate this function. $\overline{\text{MREQ}}$ and $\overline{\text{IORQ}}$ are logically "OR"ed and applied to the D input of a flip-flop clocked by the system clock. Using the Q output, the $\overline{\text{PSYNC}}$ signal is true for 500 nsec at 2 MHz and 250 nsec at 4 MHz. Refer to figure 2.

3.5 WAIT STATES

See figure 3. The Z-80 CPU board provides for a jumper selectable automatic wait state. For many applications, it may be desirable to use slow memories. The wait logic on the board allows the Z-80 to operate with slower memory. The user may select this wait state generation if required.

Z-80 Board Revision 2 Users Manual

The automatic wait state is created by setting U12-9 when either $\overline{\text{MREQ}}$ or $\overline{\text{IORQ}}$ are true (if the appropriate jumper is installed). The following clock time U12 is set to the Q state, thus turning off the wait signal. This circuit guarantees that wait will be true when the Z-80 looks for a wait.

As with 8080-based CPU's, external devices can cause the computer to enter a wait state by applying the appropriate signal to the PRDY bus line.

3.6 MISCELLANEOUS LOGIC

Logic is provided on the board to cause the PINTE bus line to set and reset upon the execution of EI (enable interrupt) and DI (disable interrupt) instructions, respectively.

The Z-80 board includes the capability to use a fast reset signal on bus line 55 to produce the $\overline{\text{RESET}}$ input to the Z-80. Alternately, as described in the User's Guide, existing circuitry on the board can be used to generate $\overline{\text{RESET}}$, using the $\overline{\text{PRESET}}$ input on line 75 of the bus. If this option is used, $\overline{\text{RESET}}$ is also generated on board when the system is initially turned on. (Using an RC time delay connected to VCC, the Z-80 $\overline{\text{RESET}}$ input is low for a short time when the system is first powered up.) Regardless of how it is generated, the $\overline{\text{RESET}}$ signal is used to generate the power on clear ($\overline{\text{POC}}$) output on bus line 99.

FIGURE 1

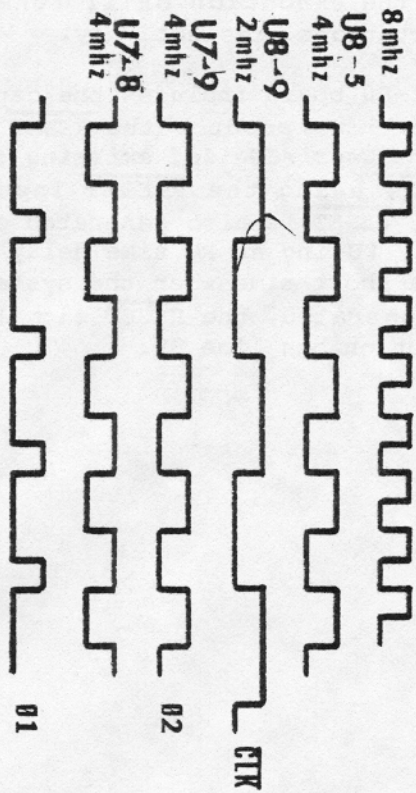

FIGURE 2

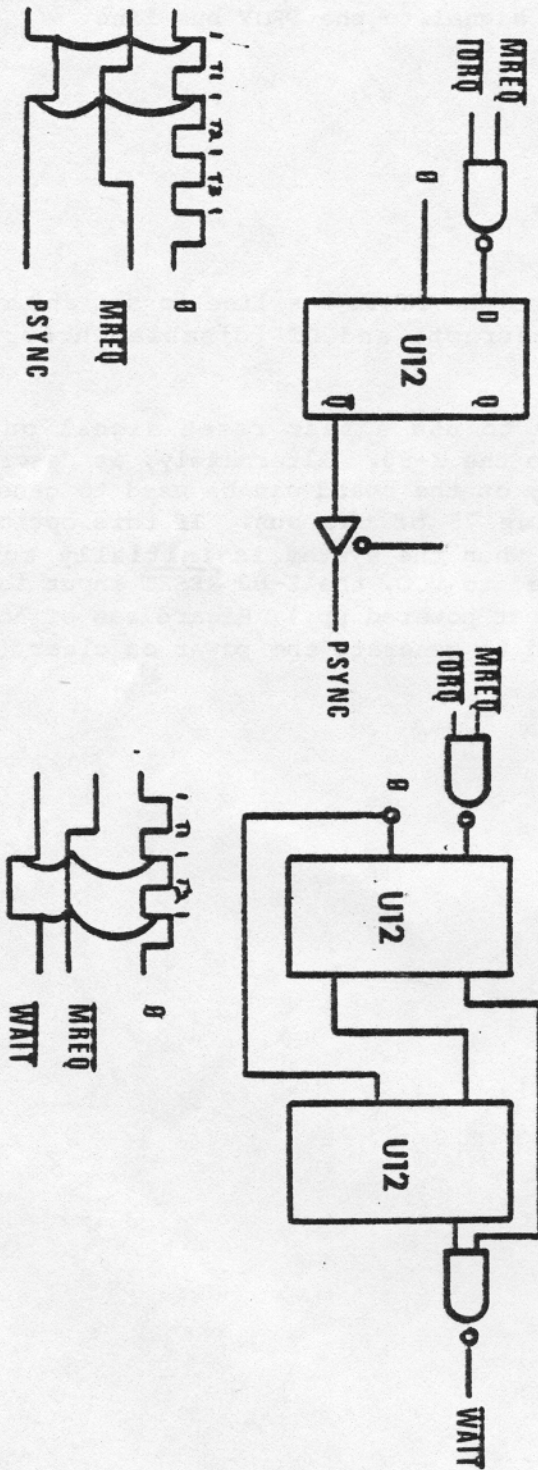
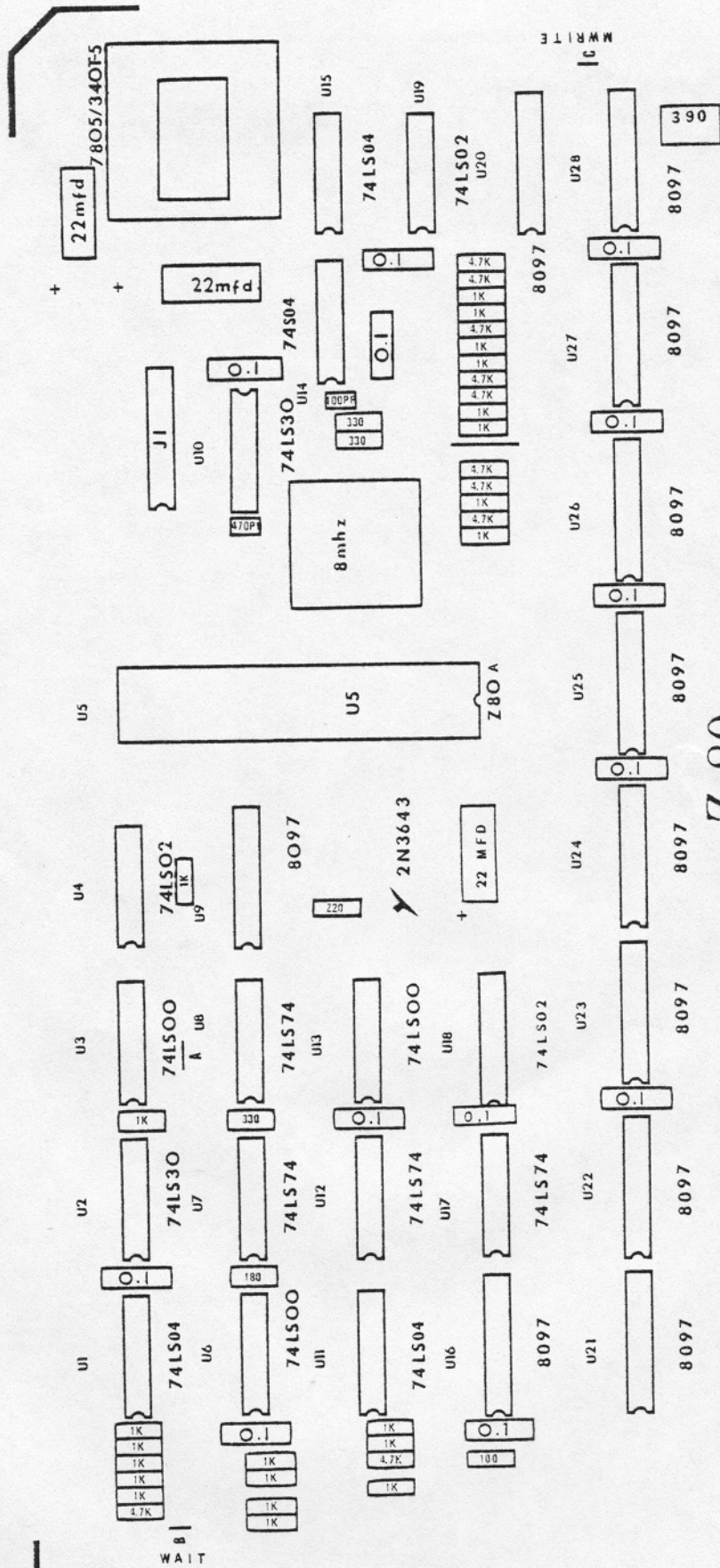

FIGURE 3

10.000



Z-80

VECTOR GRAPHIC INC.

50

0

FE

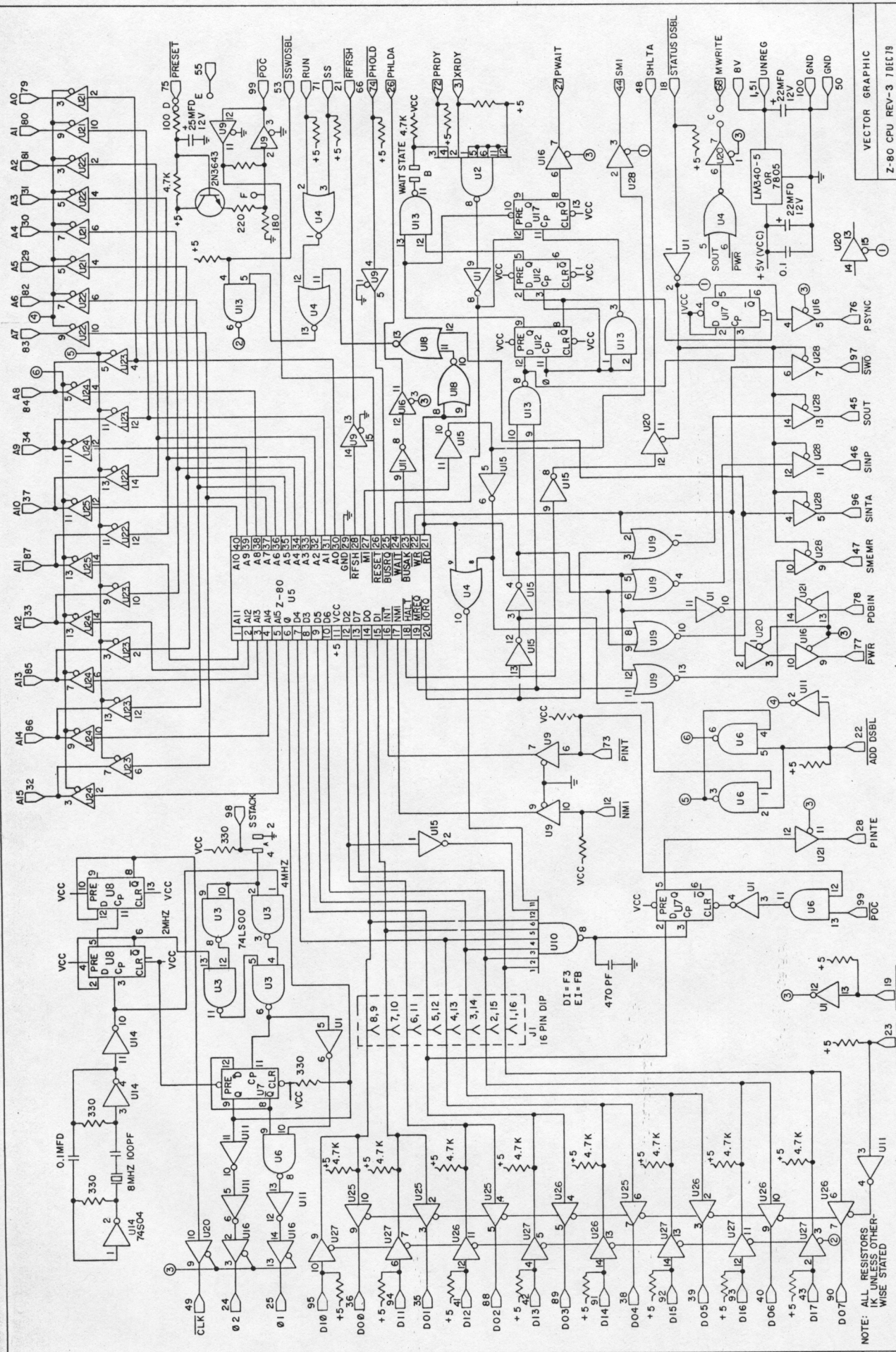

VECTOR GRAPHIC
Z-80 CPU REV-3 10E179

NOTE: ALL RESISTORS
IK UNLESS OTHER-
WISE STATED.

PRODUCT IMPROVEMENT BULLETIN

PART Z 80 Board	DATE 9/7/79	NUMBER 0044
--------------------	----------------	----------------

REASON:

To reflect artwork changes in Rev 3 Z80 Board.

DESCRIPTION OF CHANGE:

Z80 boards which are Rev 3 and later, are exempt from P I B 35.

EFFECTIVITY: A.S.A.P.

PRIORITY |

RIG. C. Ashby	DATE 9/7/79
APPVD. R. Harp	DATE 9/7/79

DISTRIBUTION:

- PRODUCTION
- TEST
- QA

- MATERIAL
- PURCHASING
- FIELD

PRODUCT IMPROVEMENT BULLETIN

PART Z-80	DATE 6-18-79	NUMBER 0035
--------------	-----------------	----------------

REASON: To remove glitches on MWRITE caused by mismatched delays of SOUT and PWR.

DESCRIPTION OF CHANGE: A. Remove 390pF capacitor

B. On circuit side:

1. Cut etch between U19-3 and feedthrough hole.
2. Jumper U19-6 to feedthrough hole that was connected to U19-3.
3. Jumper U15-13 to U19-3, U19-2 to U20-2, U20-2 to U28-6.
4. Jumper U20-3 to feed through just below U28-6.

C. On Component side:

1. Cut etch between U28-6 and 390pF capacitor pad.
2. Cut etch just below U19-2.
3. Cut etch just between U19-3 and U19-6.

D. DO NOT use 8T97 at U28, U20 and U16 in place of 8097 or 74367.

EFFECTIVITY: All new production

PRIORITY

ORIG. R. Dieges	DATE 6-18-79
APPVD.	DATE 6/18/79

DISTRIBUTION:

- PRODUCTION
- TEST
- QA

- MATERIAL
- PURCHASING
- FIELD

PRODUCT IMPROVEMENT BULLETIN

Z-80 PCBA

DATE

30 NOV, 79

NUMBER

0049

REASON:

To eliminate oscillations on the rising edge of \overline{POC} , which can cause the processor to lock-up upon power-up.

DESCRIPTION OF CHANGE:

Re-install the 22 uf/16v axial electrolytic capacitor, which had been deleted from the reset circuit.

EFFECTIVITY:

All future production

PRIORITY

Asap

BY
C. Ashby

DATE
30 NOV, 79

APPVD.
R. Harp

DATE
30 NOV, 79

DISTRIBUTION:

PRODUCTION

MATERIAL

TEST

PURCHASING

QA

FIELD



PRODUCT IMPROVEMENT BULLETIN

PART Z-80 board	DATE 11-17-78	NUMBER 0020
---------------------------	-------------------------	-----------------------

REASON: To Simplify assembly and testing of the Z-80 Board

DESCRIPTION OF CHANGE:

1. Install jumper at B
2. Do not install spring sockets at jumper A

EFFECTIVITY: New Production	PRIORITY
------------------------------------	-----------------

ORIG. Richard Dieges	DATE 11-17-78
APPVD. Robert Harp	DATE 11-17-78

DISTRIBUTION:

- PRODUCTION
- TEST
- QA
- MATERIAL
- PURCHASING
- FIELD

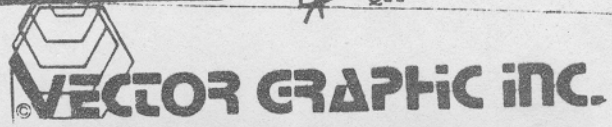

PRODUCT IMPROVEMENT BULLETIN

RT Z-80	DATE 11-15-78	NUMBER 0017
------------	------------------	----------------

REASON: To Eliminate oscillation in reset circuit.
Change 1K Resistor from U9-11 to U9-2
to 470 Ω

DESCRIPTION OF CHANGE:

- ① Change 1K resistor between U9 and U4
to 470 Ω .

EFFECTIVITY: New Production, Stock.

PRIORITY

IG. R Dieges	DATE 11-15-78
APPVD. R. Hay	DATE 11-17-78

DISTRIBUTION:

- PRODUCTION
- TEST
- QA

- MATERIAL
- PURCHASING
- FIELD

PRODUCT IMPROVEMENT BULLETIN

ART Z-80	DATE 12/8/78	NUMBER 0016
-------------	-----------------	----------------

REASON:

Silk Screen Incorrect

DESCRIPTION OF CHANGE:

The 4.7K resistor in the upper left hand corner should be 1K.
The 1K resistor to the right of it should be 4.7K.

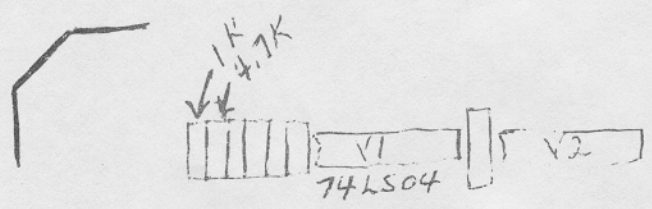

EFFECTIVITY:	All Production	PRIORITY	1
--------------	----------------	----------	---

ORIG. R. Dieges	DATE 12/8/78
APPVD. R. Harp	DATE 12/8/78

DISTRIBUTION:

- PRODUCTION
- TEST
- QA
- MATERIAL
- PURCHASING
- FIELD

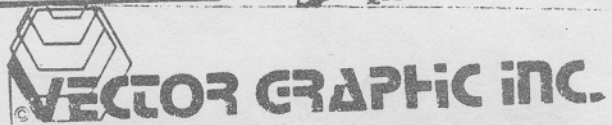

PRODUCT IMPROVEMENT BULLETIN

PART Z-80 CPU Board	DATE 10/17/78	NUMBER 0013
------------------------	------------------	----------------

REASON:

Eliminate Glitches on MWRITE Signal Line.

Note: This Bulletin cancels PIB 0008

DESCRIPTION OF CHANGE:

On the circuit side of the Z-80 Board-

Add a 390 pfd ceramic capacitor between U5 (Z-80)

Pin 22 and U4 Pin 7 (GND).

On Parts List:

	<u>QTY</u>	<u>DESCRIPTION</u>
ADD	1	<u>390</u> PF 10V Capacitor

EFFECTIVITY: All Units-in stock, production, field.

PRIORITY 1

ORIG. R. Rauch	DATE 10/5/78
APPVD. R. Rauch	DATE 10/5/78

DISTRIBUTION:

- PRODUCTION
- TEST
- QA

- MATERIAL
- PURCHASING
- FIELD

Z 80 CLOCK CIRCUIT FAILURE	Z80 BOARDS	VTA# MZ-0018
	16 JAN 1980	PAGE 1 OF 1

In the past month we have experienced problems with system B's and MZ's using the Z80 board. Upon initial power on, the system will display random characters on the screen without keyboard input. After several tries of the on-off cycle, the system will come up.

This problem has been traced to the crystal on the Z80. This can be identified by noting that the crystal has its frequency information and part numbers stamped in ink rather than stamped into the case. If a crystal of this type exhibits a problem, a new crystal should be installed. The installation of 22 MFD cap just below the IN3643 transistor may also alleviate the problem.

2